



Cisco Model DPC3212 and EPC3212 VoIP Cable Modem User Guide









In This Document

■ IMPORTANT SAFETY INSTRUCTIONS	2
■ Introduction.....	10
■ What's In the Carton?	12
■ Front Panel Description	13
■ Back Panel Description	14
■ What Are the System Requirements for Internet Service?.....	15
■ How Do I Subscribe to High-Speed Internet and Telephone Service?	16
■ Where Is the Best Location for My Cable Modem?.....	18
■ How Do I Mount the Modem on a Wall? (Optional).....	19
■ What Are the Requirements for Telephone Service?.....	22
■ How Do I Connect the Cable Modem for Internet and Telephone Service?	23
■ Installing USB Drivers.....	27
■ Frequently Asked Questions.....	29
■ Having Difficulty?	34
■ Tips for Improved Performance	35
■ Front Panel LED Status Indicator Functions.....	36
■ Notices.....	38

IMPORTANT SAFETY INSTRUCTIONS

Notice to Installers

The servicing instructions in this notice are for use by qualified service personnel only. To reduce the risk of electric shock, do not perform any servicing other than that contained in the operating instructions, unless you are qualified to do so.

<p>Note to System Installer</p> <p>For this apparatus, the coaxial cable shield/ screen shall be grounded as close as practical to the point of entry of the cable into the building. For products sold in the US and Canada, this reminder is provided to call the system installer's attention to Article 820-93 and Article 820-100 of the NEC (or Canadian Electrical Code Part 1), which provides guidelines for proper grounding of the coaxial cable shield.</p>  <p>This symbol is intended to alert you that uninsulated voltage within this product may have sufficient magnitude to cause electric shock. Therefore, it is dangerous to make any kind of contact with any inside part of this product.</p>	<table border="1"><tr><td></td><td>CAUTION RISK OF ELECTRIC SHOCK DO NOT OPEN</td><td></td></tr><tr><td></td><td>AVIS RISQUE DE CHOC ÉLECTRIQUE NE PAS OUVRIR</td><td></td></tr></table> <p>CAUTION: To reduce the risk of electric shock, do not remove cover (or back). No user-serviceable parts inside. Refer servicing to qualified service personnel.</p> <p>WARNING TO PREVENT FIRE OR ELECTRIC SHOCK, DO NOT EXPOSE THIS UNIT TO RAIN OR MOISTURE.</p>  <p>This symbol is intended to alert you of the presence of important operating and maintenance (servicing) instructions in the literature accompanying this product.</p>		CAUTION RISK OF ELECTRIC SHOCK DO NOT OPEN			AVIS RISQUE DE CHOC ÉLECTRIQUE NE PAS OUVRIR	
	CAUTION RISK OF ELECTRIC SHOCK DO NOT OPEN						
	AVIS RISQUE DE CHOC ÉLECTRIQUE NE PAS OUVRIR						



Notice à l'attention des installateurs de réseaux câblés

Les instructions relatives aux interventions d'entretien, fournies dans la présente notice, s'adressent exclusivement au personnel technique qualifié. Pour réduire les risques de chocs électriques, n'effectuer aucune intervention autre que celles décrites dans le mode d'emploi et les instructions relatives au fonctionnement, à moins que vous ne soyez qualifié pour ce faire.

<p>Remarque à l'attention de l'installateur du système</p> <p>Avec cet appareil, le blindage/écran du câble coaxial doit être mis à la terre aussi près que possible du point d'entrée du câble dans le bâtiment. En ce qui concerne les produits vendus aux États-Unis et au Canada, ce rappel est fourni pour attirer l'attention de l'installateur sur les articles 820-93 et 820-100 du Code national de l'électricité (ou Code de l'électricité canadien, Partie 1) qui fournissent des lignes directrices concernant la mise à la terre correcte du blindage (écran) du câble coaxial.</p>  <p>Ce symbole a pour but de vous prévenir que des tensions électriques non isolées existent à l'intérieur de ce produit, pouvant être d'une intensité suffisante pour causer des chocs électriques. Il est donc dangereux d'établir un contact quelconque avec l'une des pièces comprises à l'intérieur de ce produit.</p>	<table border="1"><tr><td></td><td>CAUTION RISK OF ELECTRIC SHOCK DO NOT OPEN</td><td></td></tr><tr><td></td><td>ATTENTION DANGER ÉLECTRIQUE NE PAS OUVRIR</td><td></td></tr></table> <p>ATTENTION : Pour réduire les risques de chocs électriques, ne pas enlever le couvercle (ou le panneau arrière). Ne contient aucune pièce réparable par l'utilisateur. Confier les interventions aux techniciens d'entretien qualifiés.</p> <p>AVERTISSEMENT POUR ÉVITER LES INCENDIES OU LES CHOC ÉLECTRIQUES, NE PAS EXPOSER L'APPAREIL À LA PLUIE OU À L'HUMIDITÉ.</p>  <p>Ce symbole a pour but de vous prévenir de la présence d'instructions importantes relatives au fonctionnement ou à l'entretien (et aux réparations) dans la documentation accompagnant ce produit.</p>		CAUTION RISK OF ELECTRIC SHOCK DO NOT OPEN			ATTENTION DANGER ÉLECTRIQUE NE PAS OUVRIR	
	CAUTION RISK OF ELECTRIC SHOCK DO NOT OPEN						
	ATTENTION DANGER ÉLECTRIQUE NE PAS OUVRIR						

Mitteilung für CATV-Techniker

Die in dieser Mitteilung aufgeführten Wartungsanweisungen sind ausschließlich für qualifiziertes Fachpersonal bestimmt. Um die Gefahr eines elektrischen Schlags zu reduzieren, sollten Sie keine Wartungsarbeiten durchführen, die nicht ausdrücklich in der Bedienungsanleitung aufgeführt sind, außer Sie sind zur Durchführung solcher Arbeiten qualifiziert.

<p>Mitteilung an den Systemtechniker</p> <p>Für dieses Gerät muss der Koaxialkabelschutz/ Schirm so nahe wie möglich am Eintrittspunkt des Kabels in das Gebäude geerdet werden. Dieser Erinnerungshinweis liegt den in den USA oder Kanada verkauften Produkten bei. Er soll den Systemtechniker auf Paragraph 820-93 und Paragraph 820-100 der US-Elektrovorschrift NEC (oder der kanadischen Elektrovorschrift Canadian Electrical Code Teil 1) aufmerksam machen, in denen die Richtlinien für die ordnungsgemäße Erdung des Koaxialkabelschirms festgehalten sind.</p>  <p>Dieses Symbol weist den Benutzer auf das Vorhandensein von nicht isolierten gefährlichen Spannungen im Gerät hin, die Stromschläge verursachen können. Ein Kontakt mit den internen Teilen dieses Produktes ist mit Gefahren verbunden.</p>	<table border="1"> <tr> <td></td> <td style="text-align: center;"> CAUTION RISK OF ELECTRIC SHOCK DO NOT OPEN </td> <td></td> </tr> <tr> <td></td> <td style="text-align: center;"> ACHTUNG STROMSCHLAGGEFAHR, NICHT ÖFFNEN </td> <td></td> </tr> </table> <p>ACHTUNG: Zur Vermeidung eines Stromschlags darf die Abdeckung (bzw. die Geräterückwand) nicht entfernt werden. Das Gerät enthält keine vom Benutzer wartbaren Teile. Wartungsarbeiten dürfen nur von qualifiziertem Fachpersonal durchgeführt werden.</p> <p>WARNUNG DAS GERÄT NICHT REGEN ODER FEUCHTIGKEIT AUSSETZEN, UM STROMSCHLAG ODER DURCH EINEN KURZSCHLUSS VERURSACHTEN BRAND ZU VERMEIDEN.</p>  <p>Dieses Symbol weist den Benutzer darauf hin, dass die mit diesem Produkt gelieferte Dokumentation wichtige Betriebs- und Wartungsanweisungen für das Gerät enthält.</p>		CAUTION RISK OF ELECTRIC SHOCK DO NOT OPEN			ACHTUNG STROMSCHLAGGEFAHR, NICHT ÖFFNEN	
	CAUTION RISK OF ELECTRIC SHOCK DO NOT OPEN						
	ACHTUNG STROMSCHLAGGEFAHR, NICHT ÖFFNEN						

Aviso a los instaladores de sistemas CATV

Las instrucciones de reparación contenidas en el presente aviso son para uso exclusivo por parte de personal de mantenimiento cualificado. Con el fin de reducir el riesgo de descarga eléctrica, no realice ninguna otra operación de reparación distinta a las contenidas en las instrucciones de funcionamiento, a menos que posea la cualificación necesaria para hacerlo.

<p>Nota para el instalador del sistema</p> <p>En lo que se refiere a este aparato, el blindaje del cable coaxial debe conectarse a tierra lo más cerca posible al punto por el cual el cable entra en el edificio. En el caso de los productos vendidos en los EE. UU. y Canadá, el presente aviso se suministra para llamar la atención del instalador del sistema sobre los Artículos 820-93 y 820-100 del NEC (o Código Eléctrico de Canadá, Parte 1), que proporcionan directrices para una correcta conexión a tierra del blindaje del cable coaxial.</p>  <p>Este símbolo tiene como fin advertirle de que una tensión sin aislamiento en el interior de este producto podría ser de una magnitud suficiente como para provocar una descarga eléctrica. Por consiguiente, resulta peligroso realizar cualquier tipo de contacto con alguno de los componentes internos de este producto.</p>	<table border="1"> <tr> <td></td> <td style="text-align: center;"> CAUTION RISK OF ELECTRIC SHOCK DO NOT OPEN </td> <td></td> </tr> <tr> <td></td> <td style="text-align: center;"> ATENCIÓN RIESGO DE DESCARGA ELÉCTRICA NO ABRIR </td> <td></td> </tr> </table> <p>ATENCIÓN: con el fin de reducir el riesgo de descarga eléctrica, no retire la tapa (ni la parte posterior). No existen en el interior componentes que puedan ser reparados por el usuario. Encargue su revisión a personal de mantenimiento cualificado.</p> <p>ADVERTENCIA PARA EVITAR EL RIESGO DE INCENDIO O DESCARGA ELÉCTRICA, NO EXPONGA LA UNIDAD A LA LLUVIA O A LA HUMEDAD.</p>  <p>Este símbolo tiene como fin alertarle de la presencia de importantes instrucciones de operación y mantenimiento (revisión) contenidas en la literatura que acompaña al producto.</p>		CAUTION RISK OF ELECTRIC SHOCK DO NOT OPEN			ATENCIÓN RIESGO DE DESCARGA ELÉCTRICA NO ABRIR	
	CAUTION RISK OF ELECTRIC SHOCK DO NOT OPEN						
	ATENCIÓN RIESGO DE DESCARGA ELÉCTRICA NO ABRIR						

20080814_Installer820_intl

IMPORTANT SAFETY INSTRUCTIONS

IMPORTANT SAFETY INSTRUCTIONS

- 1) Read these instructions.
- 2) Keep these instructions.
- 3) Heed all warnings.
- 4) Follow all instructions.
- 5) Do not use this apparatus near water.
- 6) Clean only with dry cloth.
- 7) Do not block any ventilation openings. Install in accordance with the manufacturer's instructions.
- 8) Do not install near any heat sources such as radiators, heat registers, stoves, or other apparatus (including amplifiers) that produce heat.
- 9) Do not defeat the safety purpose of the polarized or grounding-type plug. A polarized plug has two blades with one wider than the other. A grounding-type plug has two blades and a third grounding prong. The wide blade or the third prong are provided for your safety. If the provided plug does not fit into your outlet, consult an electrician for replacement of the obsolete outlet.
- 10) Protect the power cord from being walked on or pinched particularly at plugs, convenience receptacles, and the point where they exit from the apparatus.
- 11) Only use attachments/accessories specified by the manufacturer.
- 12)  Use only with the cart, stand, tripod, bracket, or table specified by the manufacturer, or sold with the apparatus. When a cart is used, use caution when moving the cart/apparatus combination to avoid injury from tip-over.
- 13) Unplug this apparatus during lightning storms or when unused for long periods of time.
- 14) Refer all servicing to qualified service personnel. Servicing is required when the apparatus has been damaged in any way, such as a power-supply cord or plug is damaged, liquid has been spilled or objects have fallen into the apparatus, the apparatus has been exposed to rain or moisture, does not operate normally, or has been dropped.

Power Source Warning

A label on this product indicates the correct power source for this product. Operate this product only from an electrical outlet with the voltage and frequency indicated on the product label. If you are uncertain of the type of power supply to your home or business, consult your service provider or your local power company.

The AC inlet on the unit must remain accessible and operable at all times.

Ground the Product



WARNING: Avoid electric shock and fire hazard! If this product connects to coaxial cable wiring, be sure the cable system is grounded (earthed). Grounding provides some protection against voltage surges and built-up static charges.

Protect the Product from Lightning

In addition to disconnecting the AC power from the wall outlet, disconnect the signal inputs.

Verify the Power Source from the On/Off Power Light

When the on/off power light is not illuminated, the apparatus may still be connected to the power source. The light may go out when the apparatus is turned off, regardless of whether it is still plugged into an AC power source.

Eliminate AC Mains Overloads



WARNING: Avoid electric shock and fire hazard! Do not overload AC mains, outlets, extension cords, or integral convenience receptacles. For products that require battery power or other power sources to operate them, refer to the operating instructions for those products.

Provide Ventilation and Select a Location

- Remove all packaging material before applying power to the product.
- Do not place this apparatus on a bed, sofa, rug, or similar surface.
- Do not place this apparatus on an unstable surface.
- Do not install this apparatus in an enclosure, such as a bookcase or rack, unless the installation provides proper ventilation.
- Do not place entertainment devices (such as VCRs or DVDs), lamps, books, vases with liquids, or other objects on top of this product.
- Do not block ventilation openings.

Protect from Exposure to Moisture and Foreign Objects



WARNING: Avoid electric shock and fire hazard! Do not expose this product to dripping or splashing liquids, rain, or moisture. Objects filled with liquids, such as vases, should not be placed on this apparatus.



WARNING: Avoid electric shock and fire hazard! Unplug this product before cleaning. Do not use a liquid cleaner or an aerosol cleaner. Do not use a magnetic/static cleaning device (dust remover) to clean this product.



WARNING: Avoid electric shock and fire hazard! Never push objects through the openings in this product. Foreign objects can cause electrical shorts that can result in electric shock or fire.

Service Warnings



WARNING: Avoid electric shock! Do not open the cover of this product. Opening or removing the cover may expose you to dangerous voltages. If you open the cover, your warranty will be void. This product contains no user-serviceable parts.

IMPORTANT SAFETY INSTRUCTIONS

Check Product Safety

Upon completion of any service or repairs to this product, the service technician must perform safety checks to determine that this product is in proper operating condition.

Protect the Product When Moving It

Always disconnect the power source when moving the apparatus or connecting or disconnecting cables.

Telephone Equipment Notice

When using your telephone equipment, basic safety precautions should always be followed to reduce the risk of fire, electric shock and injury to persons, including the following:

1. Do not use this product near water, for example, near a bath tub, wash bowl, kitchen sink or laundry tub, in a wet basement or near a swimming pool.
2. Avoid using a telephone (other than a cordless type) during an electrical storm. There may be a remote risk of electric shock from lightning.
3. Do not use the telephone to report a gas leak in the vicinity of the leak.



CAUTION: To reduce the risk of fire, use only No. 26 AWG or larger telecommunication line cord.

SAVE THESE INSTRUCTIONS

20090326_Modem No Battery_Safety

FCC Compliance

United States FCC Compliance

This device has been tested and found to comply with the limits for a Class B digital device, pursuant to part 15 of the FCC Rules. These limits are designed to provide reasonable protection against such interference in a residential installation. This equipment generates, uses, and can radiate radio frequency energy. If not installed and used in accordance with the instructions, it may cause harmful interference to radio communications. However, there is no guarantee that interference will not occur in a particular installation. If this equipment does cause harmful interference to radio or television reception, which can be determined by turning the equipment OFF and ON, the user is encouraged to try to correct the interference by one or more of the following measures:

- Reorient or relocate the receiving antenna.
- Increase the separation between the equipment and receiver.
- Connect the equipment into an outlet on a circuit different from that to which the receiver is connected.
- Consult the service provider or an experienced radio/television technician for help.

Any changes or modifications not expressly approved by Cisco Systems, Inc., could void the user's authority to operate the equipment.

The information shown in the FCC Declaration of Conformity paragraph below is a requirement of the FCC and is intended to supply you with information regarding the FCC approval of this device. *The phone numbers listed are for FCC-related questions only and not intended for questions regarding the connection or operation for this device. Please contact your service provider for any questions you may have regarding the operation or installation of this device.*

FC Declaration of Conformity

This device complies with Part 15 of FCC Rules. Operation is subject to the following two conditions: 1) the device may not cause harmful interference, and 2) the device must accept any interference received, including interference that may cause undesired operation.

<p style="text-align: center;">VoIP Cable Modem Model: DPC3212/EPC3212 Manufactured by: Cisco Systems, Inc. 5030 Sugarloaf Parkway Lawrenceville, Georgia 30044 USA Telephone: 770-236-1077</p>

Canada EMI Regulation

This Class B digital apparatus complies with Canadian ICES-003.

Cet appareil numérique de la class B est conforme à la norme NMB-003 du Canada.

20081121 FCC Standard

CE Compliance

Declaration of Conformity with Regard to the EU Directive 1999/5/EC (R&TTE Directive)

This declaration is only valid for configurations (combinations of software, firmware and hardware) supported or provided by Cisco Systems for use within the EU. The use of software or firmware not supported or provided by Cisco Systems may result in the equipment no longer being compliant with the regulatory requirements.

Български [Bulgarian]:	Това оборудване отговаря на съществените изисквания и приложими клаузи на Директива 1999/5/EC.
Česky [Czech]:	Toto zařízení je v souladu se základními požadavky a ostatními odpovídajícími ustanoveními Směrnice 1999/5/EC.
Dansk [Danish]:	Dette udstyr er i overensstemmelse med de væsentlige krav og andre relevante bestemmelser i Direktiv 1999/5/EF.
Deutsch [German]:	Dieses Gerät entspricht den grundlegenden Anforderungen und den weiteren entsprechenden Vorgaben der Richtlinie 1999/5/EU.
Eesti [Estonian]:	See seade vastab direktiivi 1999/5/EU olulistele nõuetele ja teistele asjakohastele sätetele.
English:	This equipment is in compliance with the essential requirements and other relevant provisions of Directive 1999/5/EC.
Español [Spanish]:	Este equipo cumple con los requisitos esenciales así como con otras disposiciones de la Directiva 1999/5/CE.
Ελληνική [Greek]:	Αυτός ο εξοπλισμός είναι σε συμμόρφωση με τις ουσιαστικές απαιτήσεις και άλλες σχετικές διατάξεις της Οδηγίας 1999/5/EC.
Français [French]:	Cet appareil est conforme aux exigences essentielles et aux autres dispositions pertinentes de la Directive 1999/5/EC.
Íslenska [Icelandic]:	Þetta tæki er samkvæmt grunnkröfum og öðrum viðeigandi ákvæðum Tilskipunar 1999/5/EC.
Italiano [Italian]:	Questo apparato è conforme ai requisiti essenziali ed agli altri principi sanciti dalla Direttiva 1999/5/CE.
Latviski [Latvian]:	Šī iekārta atbilst Direktīvas 1999/5/EK būtiskajām prasībām un citiem ar to saistītajiem noteikumiem.
Lietuvių [Lithuanian]:	Šis įrenginys tenkina 1999/5/EB Direktyvos esminius reikalavimus ir kitas šios direktyvos nuostatas.
Nederlands [Dutch]:	Dit apparaat voldoet aan de essentiële eisen en andere van toepassing zijnde bepalingen van de Richtlijn 1999/5/EC.
Malta [Maltese]:	Dan l-apparat huwa konformi mal-ftigiet essenzjali u l-provedimenti l-oħra rilevanti tad-Direttiva 1999/5/EC.
Magyar [Hungarian]:	Ez a készülék teljesíti az alapvető követelményeket és más 1999/5/EK irányelvben meghatározott vonatkozó rendelkezéseket.
Norsk [Norwegian]:	Dette utstyret er i samsvar med de grunnleggende krav og andre relevante bestemmelser i EU-direktiv 1999/5/EF.
Polski [Polish]:	Urządzenie jest zgodne z ogólnymi wymaganiami oraz szczególnymi warunkami określonymi Dyrektywą UE: 1999/5/EC.
Português [Portuguese]:	Este equipamento está em conformidade com os requisitos essenciais e outras provisões relevantes da Directiva 1999/5/EC.
Română [Romanian]:	Acest echipament este în conformitate cu cerințele esențiale și cu alte prevederi relevante ale Directivei 1999/5/EC.
Slovensko [Slovenian]:	Ta naprava je skladna z bistvenimi zahtevami in ostalimi relevantnimi pogoji Direktive 1999/5/EC.
Slovensky [Slovak]:	Toto zariadenie je v zhode so základnými požiadavkami a inými príslušnými nariadeniami direktív: 1999/5/EC.
Suomi [Finnish]:	Tämä laite täyttää direktiivin 1999/5/EY olennaiset vaatimukset ja on siinä asetettujen muiden laitetta koskevien määräysten mukainen.
Svenska [Swedish]:	Denna utrustning är i överensstämmelse med de väsentliga kraven och andra relevanta bestämmelser i Direktiv 1999/5/EC.

Note: The full declaration of conformity for this product can be found in the Declarations of Conformity and Regulatory Information section of the appropriate product hardware installation guide, which is available on Cisco.com.

The following standards were applied during the assessment of the product against the requirements of the Directive 1999/5/EC:

- EMC: EN 55022 and EN 55024
EN 61000-3-2 and EN 61000-3-3
- Safety: EN 60950-1

This product conforms to the following European directives:

 -1999/5/EC
-2006/95/EC
-2004/108/EC

20090312 CE_Modem/EMTA

Introduction

Welcome to the exciting world of high-speed Internet and high-quality digital telephone service. Your new DPC3212 or EPC3212 Voice-over-Internet Protocol (VoIP) Cable Modem is a modem that meets industry standards for high-speed data connectivity along with reliable digital telephone service. With this cable modem, your Internet enjoyment, home and business communications, and personal productivity will surely soar.

This guide provides procedures and recommendations for placing, installing, configuring, operating, and troubleshooting your DPC3212 or EPC3212 cable modem for high-speed Internet or digital telephone service for your home or office. Refer to the appropriate section in this guide for the specific information you need for your situation. Contact your service provider for more information about subscribing to these services.

Benefits and Features

Your new cable modem offers the following outstanding benefits and features:

- Includes an embedded media terminal adapter (EMTA) supporting two-line voice services
- Provides a high-speed broadband Internet connection that energizes your online experience, which makes downloading and sharing files and photos with your family and friends hassle free
- Includes 10/100/1000BASE-T Ethernet and USB ports to provide connectivity for high-speed data services or to other Internet devices
- Assures a broad range of interoperability with most service providers to deliver high-end performance and reliability. The DPC3212 complies with Data Over Cable System Interface Specifications (DOCSIS®) 1.0, 1.1, 2.0, and 3.0 standards along with PacketCable™ 1.5 specifications. The EPC3212 complies with EuroDOCSIS™ 1.0, 1.1, 2.0, and 3.0 standards along with EuroPacketCable™ 1.5 specifications.
- Includes two RJ-11 telephony ports for connecting conventional telephones or fax machines
- Allows you to attach multiple devices in your home or office to the cable modem for high-speed networking and sharing of files and folders without first copying them onto a CD or diskette

- Features Plug and Play operation for easy set up and installation
- Provides parental control and advanced firewall technology
- Uses an attractive compact design that allows for table or wall-mount placement
- Allows automatic software upgrades by your service provider

What's In the Carton?

When you receive your cable modem, you should check the equipment and accessories to verify that each item is in the carton and that each item is undamaged. The carton contains the following items:



One DPC3212 or EPC3212 VoIP Cable Modem



One AC power adapter with power cord



One Ethernet cable (Ethernet cable may not be provided with all products)



One USB cable (USB cable may not be provided with all products.)



One CD-ROM containing the user guide and the USB drivers

If any of these items are missing or damaged, please contact your service provider for assistance.

Notes:

- You need a cable signal splitter and additional standard RF coaxial cables if you want to connect a VCR, a Digital Home Communications Terminal (DHCT) or a set-top converter, or a TV to the same cable connection as your wireless home gateway.
- Cables and other equipment needed for telephone service must be purchased separately. Contact your service provider to inquire about the equipment and cables you need for telephone service.

Front Panel Description

The front panel of your cable modem provides status LEDs that indicate how well and at what state your cable modem is operating. See *Front Panel LED Status Indicator Functions* (on page 36) for more information on front-panel LED status indicator functions.

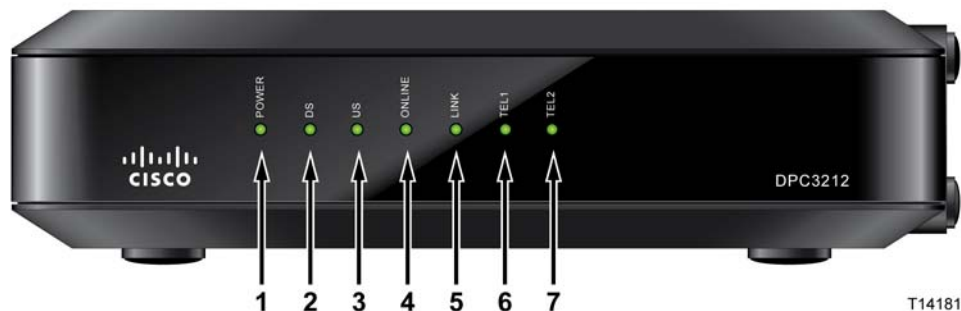

- 1 **POWER** – Illuminates continuously to indicate that AC power is being applied to the cable modem
- 2 **DS (Downstream)** – Indicates continuously the status of the connection for receiving data. Illuminates during normal operation
- 3 **US (Upstream)** – Indicates the status of the connection for sending data. Illuminates continuously during normal operation
- 4 **ONLINE** – Illuminates continuously when the cable modem is registered on the network and fully operational. This indicator blinks to indicate one of the following conditions:
 - The cable modem is booting up and not ready for data.
 - The cable modem is scanning the network and attempting to register.
 - The cable modem has lost registration on the network and will continue blinking until it registers again.
- 5 **LINK** – Illuminates continuously to indicate that an Ethernet/USB carrier is present and blinks to indicate that Ethernet/USB data is being transferred between the PC and the cable modem.
- 6 **TEL 1** – Illuminates continuously when VoIP service is enabled. Blinks when line 1 is in use
- 7 **TEL 2** – Illuminates continuously when VoIP service is enabled. Blinks when line 2 is in use

Note: After the cable modem is successfully registered on the network, the **POWER** (LED 1), **DS** (LED 2), **US** (LED 3), and **ONLINE** (LED 4) LEDs illuminate continuously to indicate that the cable mode is active and fully operational.

Back Panel Description

The following illustration shows the description and function of the back panel components on the DPC3212 and EPC3212.

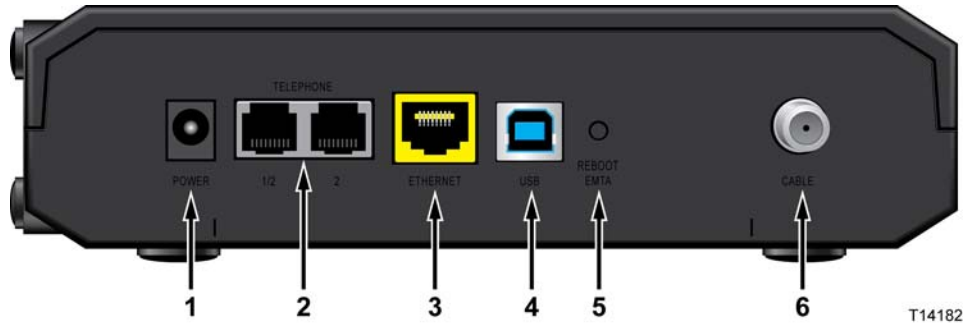

Important: Do not connect your PC to *both* the **ETHERNET** and **USB** ports at the same time. Your modem will not function properly if both the **ETHERNET** and **USB** ports are connected to your PC at the same time.

- 1 **POWER** – Connects the cable modem to the AC power supply that is provided with your cable modem



CAUTION:

Avoid damage to your equipment. Only use the AC power adapter that is provided with your cable modem.

- 2 **TEL 1/TEL 2** – RJ-11 telephone ports connect to home telephone wiring to conventional telephones or fax machines
- 3 **ETHERNET** – RJ-45 Ethernet port connects to the 10/100/1000BASE-T Ethernet port on your PC or your home network
- 4 **USB** – 12 Mbps USB 1.1 port connects to the USB port on your PC
- 5 **REBOOT EMTA** – Pressing this switch reboots the EMTA. Pressing this switch for more than three seconds resets the device to factory default values and reboots the EMTA



CAUTION:

The **REBOOT EMTA** button is for maintenance purposes only. Do not use unless instructed to do so by your service provider. Doing so may cause you to lose any cable modem settings you have selected.

- 6 **CABLE** – F-Connector connects to an active signal from your service provider

What Are the System Requirements for Internet Service?

To ensure that your cable modem operates efficiently for high-speed Internet service, verify that all of the Internet devices on your system meet or exceed the following minimum hardware and software requirements.

Note: You will also need an active cable input line and an Internet connection.

Minimum System Requirements for a PC

- A PC with a Pentium MMX 133 processor or greater
- 32 MB of RAM
- Web browsing software
- CD-ROM drive

Minimum System Requirements for Macintosh

- MAC OS 7.5 or later
- 32 MB of RAM

System Requirements for an Ethernet Connection

- A PC with Microsoft Windows 2000 operating system (or later) with TCP/IP protocol installed, or an Apple Macintosh computer with TCP/IP protocol installed
- An active 10/100/1000BASE-T Ethernet network interface card (NIC) installed

System Requirements for a USB Connection

- A PC with Microsoft Windows 2000 operating system (or later)
- A master USB port installed in your PC

How Do I Subscribe to High-Speed Internet and Telephone Service?

Before you can use your cable modem, you need to have a high-speed Internet access account. If you do not have a high-speed Internet access account, you need to set up an account with your local service provider. Choose one of the options in this section.

I Do Not Have a High-Speed Internet Access Account

If you do *not* have a high-speed Internet access account, your service provider will set up your account and become your Internet Service Provider (ISP). Internet access enables you to send and receive e-mail, access the World Wide Web, and receive other Internet services.

You will need to give your service provider the following information:

- The serial number of the modem
- The Media Access Control (MAC) address of the modem (CM MAC)

These numbers appear on a bar code label located on the cable modem. The serial number consists of a series of alphanumeric characters preceded by **S/N**. The MAC address consists of a series of alphanumeric characters preceded by **CM MAC**. The following illustration shows a sample bar code label.

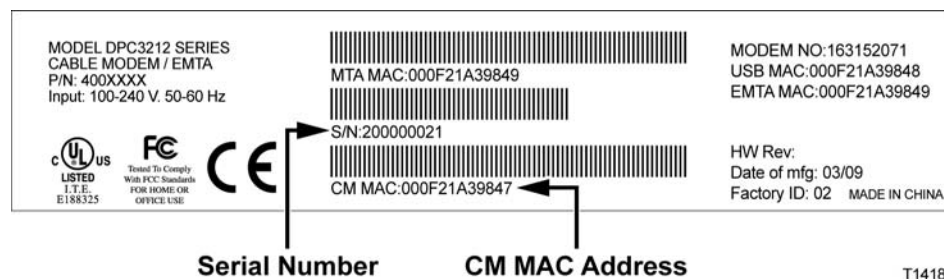

Write down these numbers in the space provided here.

Serial Number _____

MAC Address _____

I Already Have an Existing High-Speed Internet Access Account

If you have an existing high-speed Internet access account, you must give your service provider the serial number and the MAC address of the cable modem. Refer to the serial number and MAC address information listed previously in this section.

I Want to Use the Cable Modem for Telephone Service

You will also need to set up a telephone account with your local service provider to use your cable modem for telephone service. When you contact your service provider, you may be able to transfer your existing telephone numbers, or your cable telephony service provider will assign a new telephone number for each current or additional active telephone line. Discuss these options with your telephony service provider.

Where Is the Best Location for My Cable Modem?

The ideal location for your cable modem is where it has access to outlets and other devices. Think about the layout of your home or office, and consult with your service provider to select the best location for your cable modem. Read this user guide thoroughly before you decide where to place your cable modem.

Consider these recommendations:

- Position your PC and cable modem so that they are located near an AC power outlet.
- Position your PC and cable modem so that they are located near an existing cable input connection to eliminate the need for an additional cable outlet. There should be plenty of room to guide the cables away from the modem and the PC without straining or crimping them.
- Airflow around the cable modem should not be restricted.
- Choose a location that protects the cable modem from accidental disturbance or harm.

How Do I Mount the Modem on a Wall? (Optional)

You can mount the cable modem on a wall using two wall anchors, two screws, and the mounting slots located on the unit. The modem can be mounted horizontally.

Before You Begin

Before you begin, choose an appropriate mounting place. The wall can be made of cement, wood, or drywall. The mounting location should be free of obstructions on all sides, and the cables should be able to easily reach the cable modem without strain. Leave sufficient clearance between the bottom of the cable modem and any flooring or shelving underneath to allow access to cabling. In addition, leave enough slack in all cables so that the cable modem can be removed for any required maintenance without disconnecting the cables. Also, verify that you have the following items:

- Two wall anchors for #8 x 1-inch screws
- Two #8 x 1-inch pan head sheet metal screws
- Drill with a 3/16-inch wood or masonry bit, as appropriate for the wall composition

Note: A copy of the wall-mounting illustration is shown on the following page.

How Do I Mount the Modem on a Wall? (Optional)

Mount the modem as shown in the following illustration.

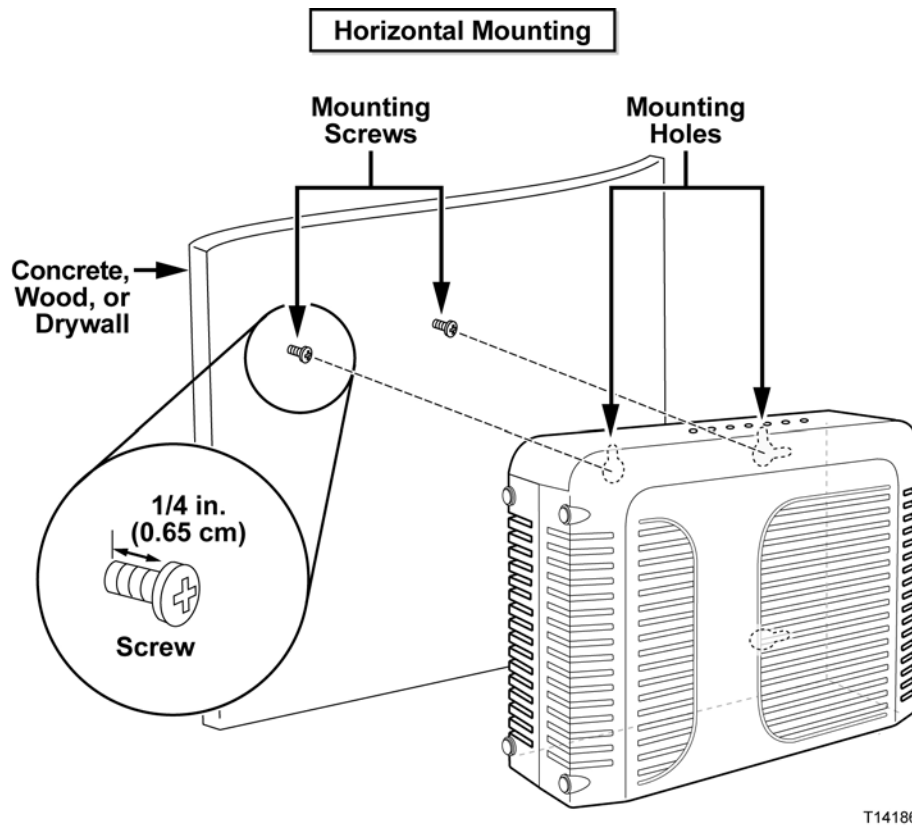

Location and Dimensions of the Wall-Mounting Slots

The following illustration shows the location and dimensions of the wall-mounting slots on the bottom of the modem. Use the information on this page as a guide for mounting your modem to the wall.

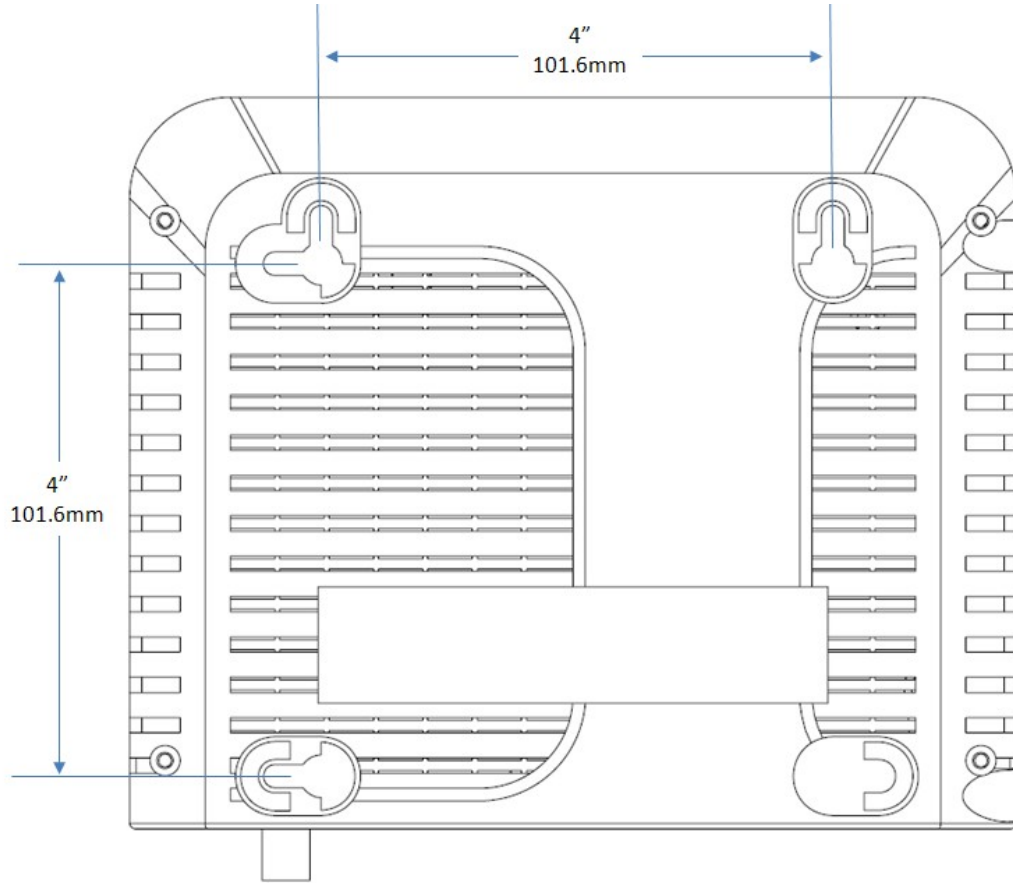

What Are the Requirements for Telephone Service?

This section provides hardware and software requirements for using your cable modem for telephone service.

Number of Telephone Devices

The RJ-11 telephone-style connectors on the cable modem can each provide telephone service to multiple telephones, fax machines, and analog modems.

The maximum number of telephone devices connected to each RJ-11 port is limited by the total Ringing Load of the telephone devices that are connected. Many telephone devices are marked with a Ringer Equivalent Number (REN). Each telephone port on the cable modem can support up to a 5 REN load.

The sum of the REN load on all of the telephone devices attached to each port must not exceed 5 REN.

Telephone Device Types

You can use telephone devices that are not labeled with a REN number, but the maximum number of attached telephone devices cannot be accurately calculated. With telephone devices that are not labeled, each device should be connected and the ring signal should be tested before adding more devices. If too many telephone devices are attached and the ring signal can no longer be heard, telephone devices should be removed until the ring signal works properly.

Telephones, fax machines, and other telephone devices should use the center 2 pins of the RJ-11 connectors to connect to the cable modem telephone ports. Some telephones use other pins on the RJ-11 connectors and require adapters in order to work.

Dialing Requirements

All your telephones should be set to use DTMF dialing. Pulse dialing is typically not enabled by your local provider.

Telephone Wiring Requirements

The cable modem supports interior telephone wiring. The maximum distance from the unit to the most distant telephone device must not exceed 1000 feet (300 meters). Use 26-gauge twisted-pair, or larger, telephone wiring.

Important: Connection to an existing or a new permanently installed home telephone wiring network must be done by a qualified installer.

How Do I Connect the Cable Modem for Internet and Telephone Service?

You can use the cable modem to provide both telephone service and to provide Internet access, and you can share that Internet connection with other Internet devices in your home or office. Sharing one connection among many devices is called networking.

Connecting and Installing Internet Devices

Professional installation may be available. Contact your local service provider for further assistance.

To connect devices

The following diagram illustrates one of the various networking options that are available to you.

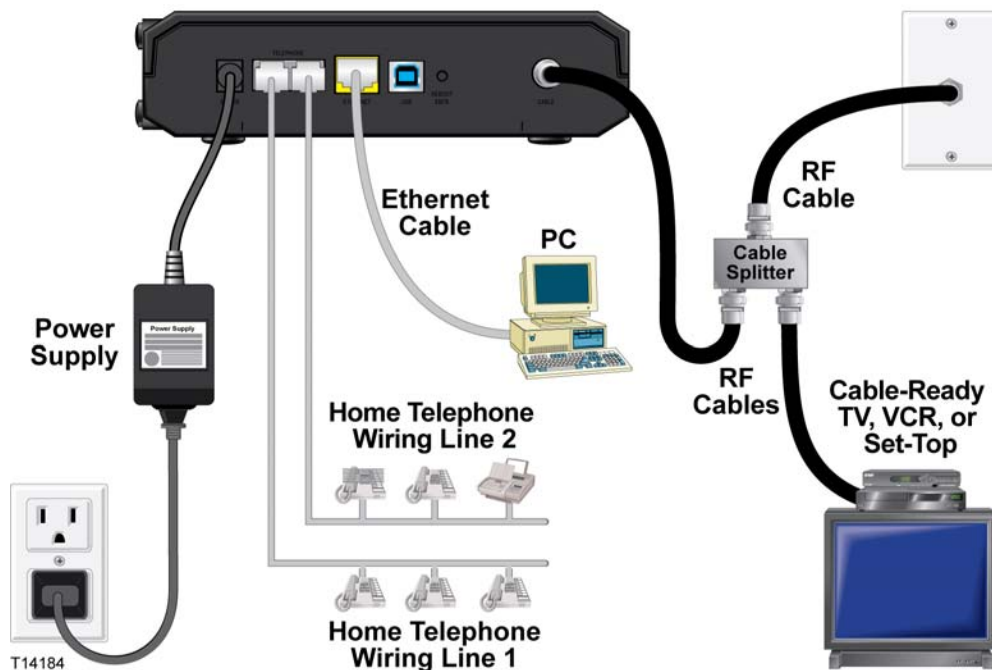

Connecting the Cable Modem for High-Speed Data and Telephone Service

The following installation procedure ensures proper setup and configuration for the cable modem.

- 1 Choose an appropriate and safe location to install the cable modem (close to a power source, an active cable connection, your PC – if using high-speed Internet, and your telephone lines – if using VoIP).



WARNING:

- To avoid personal injury, follow the installation instructions in the exact order shown.
- To prevent possible damage to equipment, disconnect any other telephone service before connecting your cable modem to the same wires.
- Hazardous electrical voltages can exist on the telephone ports on the cable modem and can be present on any connected wiring including Ethernet wiring, telephone wiring and coax cable.
- Telephone wiring and connections must be properly insulated to prevent electrical shock.
- Telephone connections to an installed home telephone wiring network must be done by a qualified installer. The cable telephone service provider may offer professional installation and connection to the home telephone wiring network. A fee may be charged for this service.
- Wiring and connections must be properly insulated to prevent electrical shock.
- Disconnect power from the cable modem before attempting to connect to any device.

- 2 Power off your PC and other networking device; then, unplug them from the power source.
- 3 Connect the active RF coaxial cable from your service provider to the coax connector labeled **CABLE** on the back of the cable modem.

Note: To connect a TV, DHCT, set-top, or VCR from the same cable connection, you will need to install a cable signal splitter (not included). Always check with your service provider before using a splitter as a splitter may degrade the signal.

- 4 Connect your PC to the cable modem using either of the following methods.
 - **Ethernet Connection:** Locate the yellow Ethernet cable, connect one end of the Ethernet cable to the Ethernet port on your PC, and connect the other end to the yellow **ETHERNET** port on the back of the cable modem.

Note: To install more Ethernet devices than ports provided on the cable modem, use an external multi-port Ethernet switch(s).
 - **USB Connection:** Locate the blue USB cable, connect one end of the cable to an available USB port on your PC, and connect the other end to the blue **USB** port on the back of the cable modem.

Important: When using a USB connection, you need to install USB drivers on your PC. For assistance, go to *Installing USB Drivers* (on page 27).

Note: You can connect two separate PCs to the cable modem at the same time by connecting one PC to the **ETHERNET** port and one PC to the **USB** port. However, do not connect your PC to both the **ETHERNET** and **USB** ports at the same time.
- 5 Connect one end of a telephone jumper cable (not included) to a telephone outlet in your home or to a telephone or fax machine. Then connect the other end of the jumper cable to the appropriate RJ-11 **TELEPHONE** port on the back of the cable modem. The telephone ports are light gray and are labeled 1/2 and 2 or 1 and 2 depending on the region of the world the cable modem is used.

Notes:

 - Make sure to connect your telephone service to the correct RJ-11 port. For single line telephone service, connect to port 1/2 or 1.
 - In North America, cable modems have multi-line capability on the RJ-11 telephone port labeled 1/2. Line 1 is on pins 3 and 4 of port 1/2, and Line 2 is supported on pins 2 and 5. In Europe, cable modems support only one line per port. Line 1 is on port 1 and line 2 is on port 2.
 - Telephones that require electrical connectors other than RJ-11 may require an external adapter (sold separately).
- 6 Locate the AC power cord provided with your cable modem. Insert one end of the power cord into the AC connector on the back of the cable modem. Then, plug the AC power cord into an AC outlet to power-up the cable modem. The cable modem will perform an automatic search to locate and sign on to the broadband data network. This process may take up to 2-5 minutes. The modem will be ready for use when the **POWER**, **DS**, **US** and **ONLINE** LEDs on the front panel of the cable modem stop blinking and remain on continuously.

How Do I Connect the Cable Modem for Internet and Telephone Service?

- 7 Plug in and power on your PC and other home network devices. The **LINK** LED on the cable modem corresponding to the connected devices should be on or blinking.
- 8 Once the cable modem is online, most Internet devices will have immediate Internet access.

Note: If your PC does not have Internet access, refer to *Frequently Asked Questions* (on page 29) for information on how to configure your PC for TCP/IP. For Internet devices other than PCs, refer to the DHCP or IP Address configuration section of the User Guide or Operations Manual for those devices.

Installing USB Drivers

Your IP cable modem features multiple networking interfaces that allow you to connect consumer electronic devices to your home network. USB 1.1 is one of the technologies that enables Microsoft Windows-based PCs to connect to the home network.

Important: Due to the inherent speed limitations of the technology, USB 1.1 is not the optimal interface for high-speed networking. The USB 1.1 port should only be used when there is no other interface available on your PC for connecting to the network.

This section contains instructions for installing USB drivers if your PC is equipped with a USB interface and a Microsoft Windows 2000, XP, or Vista operating system. The USB driver installation procedures are different for each operating system. Follow the appropriate instructions in this section for your operating system.

Note: If you are not using the USB interface, skip this section.

Installing USB Drivers on Windows 2000 Systems

- 1 Insert the **USB Cable Modem Driver Installation Disk** into the CD-ROM drive of your PC.
- 2 Make sure the power is connected to your cable modem and that the **POWER** LED status indicator on the front panel of the cable modem illuminates solid.
- 3 Connect the USB cable to your computer's USB port. Then, connect the other end of the USB cable to the **USB** port on the cable modem.
- 4 Click **Next** in the Found New Hardware Wizard window.
- 5 Select **Search for a suitable driver for my device (recommended)** in the Found New Hardware Wizard window, and then click **Next**.
- 6 Select **CD-ROM drives** in the Found New Hardware Wizard window, and then click **Next**.
- 7 Click **Next** in the Found New Hardware Wizard window. The system searches for the driver file for your hardware device.
- 8 After the system finds the USB driver, the Digital Signature Not Found window opens and displays a confirmation message to continue the installation.
- 9 Click **Yes** to continue the installation. The Found New Hardware Wizard window reopens with a message that the installation is complete.
- 10 Click **Finish** to close the Found New Hardware Wizard window. The USB drivers are installed on your PC, and your USB devices are ready for use.
- 11 Try to access the Internet. If you cannot access the Internet, go to *Having Difficulty?* (on page 34). If you still cannot access the Internet, contact your service provider for further assistance.

Installing USB Drivers on Windows XP Systems

- 1 Insert the **USB Cable Modem Driver Installation Disk** into the CD-ROM drive of your PC.
- 2 Wait until the **POWER** and **ONLINE** LED status indicators on the front panel of the cable modem illuminate solid.
- 3 Select **Install from a list or specific location (Advanced)** in the Found New Hardware Wizard window, and then click **Next**.
- 4 Select **Search removable media (floppy, CD-ROM)** in the Found New Hardware Wizard window, and then click **Next**.
- 5 Click **Continue Anyway** in the Hardware Installation window to continue the installation. The Found New Hardware Wizard window reopens with a message that the installation has finished.
- 6 Click **Finish** to close the Found New Hardware Wizard window. The USB drivers are installed on your PC, and your USB devices are ready for use.
- 7 Try to access the Internet. If you cannot access the Internet, go to *Having Difficulty?* (on page 34). If you still cannot access the Internet, contact your service provider for further assistance.

Installing USB Drivers on Windows Vista Systems

- 1 Insert the **USB Cable Modem Driver Installation Disk** into the CD-ROM drive of your PC.
- 2 Wait until the **POWER** and **ONLINE** LED status indicators on the front panel of the cable modem illuminate solid.
- 3 Follow the onscreen instructions to complete the installation.
- 4 Try to access the Internet. If you cannot access the Internet, go to *Having Difficulty?* (on page 34). If you still cannot access the Internet, contact your service provider for further assistance.

Frequently Asked Questions

Q. What if I don't subscribe to telephone service from my cable operator, can I still use the cable modem to make and receive phone calls?

A. No. Telephone service is enabled for each telephone port on the cable modem by the cable telephony service provider. Contact your cable telephony service provider to get telephone service through the cable modem.

Q. How do I arrange for cable telephony installation?

A. Professional installation from your cable telephony service provider may be provided. A professional installer can connect the telephone service to your existing telephone wiring in your home or install new wiring if needed. Professional installation also ensures proper cable connection to the modem and to your PC, and ensures proper configuration of all hardware and software settings. Contact your cable telephony service provider for more information about installation.

Q. How does the cable modem connect to my computer?

A. The cable modem connects to the USB port or to the Ethernet port on your PC. If you want to use an Ethernet interface, Ethernet cards available from your local PC or office supply retailer, or from your service provider.

Q. After my cable modem is connected, how do I access the Internet?

A. Your local service provider becomes your Internet Service Provider (ISP). They offer a wide range of services including e-mail, chat, news, and information services. Your service provider will provide the software you will need.

Q. Can I watch TV and surf the Internet at the same time?

A. Absolutely! If you subscribe to cable television service, you can watch TV and use your cable modem at the same time by connecting your TV and your cable modem to the cable network using an optional cable signal splitter.

Q. Can I surf the Internet and make telephone calls at the same time?

A. Absolutely! Telephone service is provided separately from Internet data services. Internet surfing and other data services do not affect the quality of your telephone calls. If these services are enabled by your cable service provider, you can make telephone calls and surf the net at the same time.

Q. Can I use my existing phone number with the cable modem?

A. Telephone numbers are portable in some areas. Contact your telephone service provider for more information about using an existing telephone number.

Q. Do I automatically receive high-speed Internet service with the cable modem?

A. Your cable modem may be used to provide telephone service, high-speed Internet service, or both services. Your cable service provider enables Internet service. Contact your cable service provider for more information if you are not currently subscribing to Internet service.

Q. How many telephones can I connect?

A. The RJ-11 telephone-style connectors on the cable modem can each provide telephone service to multiple telephones, fax machines, and analog modems. The maximum number of telephone devices connected to each RJ-11 port is limited by the total Ringing Load of the telephone devices that are connected. Many telephone devices are marked with a Ringer Equivalent Number (REN). Each telephone port on the cable modem can support up to a 5 REN load. The sum of the REN load on all of the telephone devices attached to each port must not exceed 5 REN.

Q. Can I run more than one device on the modem?

A. Yes. A single cable modem will theoretically support up to 253 Ethernet devices utilizing user-supplied Ethernet hubs or routers that you can purchase at your local PC or office supply retailer. Another user at your location can simultaneously connect to the **USB** port on the cable modem. Contact your service provider for further assistance.

Q. How do I renew the IP address on my PC?

A. If your PC cannot access the Internet after the cable modem is online, it is possible that your PC did not renew its IP address. Follow the appropriate instructions in this section for your operating system to renew the IP address on your PC.

Renewing the IP Address on Windows 2000 or XP Systems

- 1 Click **Start**, and then click **Run**. The Run window opens.
- 2 Type **cmd** in the Open field and click **OK**. A window with a command prompt opens.
- 3 Type **ipconfig/release** at the C:/ prompt and press **Enter**. The system releases the IP address.
- 4 Type **ipconfig/renew** at the C:/ prompt and press **Enter**. The system displays a new IP address.
- 5 Click the **X** in the upper-right corner of the window to close the Command Prompt window. You have completed this procedure.

Note: If you cannot access the Internet, contact your service provider for further assistance.

Renewing the IP Address on Macintosh Systems

- 1 Close all open programs.
- 2 Open your **Preferences** folder.
- 3 Drag the **tcp/ip preferences** file to the Trash.
- 4 Close all open windows and empty the Trash.
- 5 Restart your computer.
- 6 As your computer starts, simultaneously press and hold down the **Command (Apple), Option, P,** and **R** keys on your keyboard. Keeping those keys pressed down, power on your Macintosh but do not release these keys until you hear the Apple chime at least three times; then, release the keys and let the computer restart.
- 7 When your computer fully reboots, click the **Apple** icon in the upper-left corner of the Finder. Scroll down to **Control Panels**, and then click **TCP/IP**.
- 8 Click **Edit** on the Finder at the top of the screen. Scroll down to the bottom of the menu, and then click **User Mode**.
- 9 Click **Advanced** in the User Mode window, and then click **OK**.
- 10 Click the Up/Down selector arrows located to the right of the Connect Via section of the TCP/IP window, and then click **Using DHCP Server**.
- 11 Click **Options** in the TCP/IP window, and then click **Active** in the TCP/IP Options window.

Note: In some cases, the **Load only when needed** option does not appear. If it appears, select the option. A check mark appears in the option.
- 12 Verify that the **Use 802.3** option located in the upper-right corner of the TCP/IP window is not selected. If there is a check mark in the option, select the option to clear the check mark, and then click **Info** in the lower-left corner.
- 13 Is there a Hardware Address listed in this window?
 - If **yes**, click **OK**. To close the TCP/IP Control Panel window, click **File**, and then scroll down to click **Close**.
 - If **no**, repeat these instructions from step 6.
- 14 Reboot your computer.

Q. How do I configure my PC for TCP/IP?

A. If your PC cannot access the Internet after the cable modem is online, it is possible that your PC did not have been configured for TCP/IP. Follow the appropriate instructions in this section for your operating system to configure your PC for TCP/IP.

Configuring TCP/IP on Windows XP Systems

- 1 Click **Start**, and depending on your Start menu setup, choose one of the following options:
 - If you are using the Windows XP Default Start Menu, select **Connect to**, choose **Show all connections**, and then go to step 2.
 - If you are using the Windows XP Classic Start Menu, select **Settings**, choose **Network Connections**. Double-click the **Local Area Connection** icon in the LAN or High-Speed Internet section of the Network Connections window.
- 2 When the Network Connections window opens, right click on **Local Area Connection**, left click on **Properties** from the menu to open the Properties dialogue box.
- 3 Locate a white box titled "This connection uses the following items:". Use the down arrow on the right side of the box to scroll down until you see Internet Protocol (TCP/IP). Select **Internet Protocol (TCP/IP)**, then click the **Properties** button below the white box on the right hand side.
- 4 Select both **Obtain an IP address automatically** and **Obtain DNS server address automatically** in the Internet Protocol (TCP/IP) Properties window, and then click **OK**.
- 5 Click **OK** at the bottom of the properties box to close the box. At this point, your PC will automatically request and receive an IP address from that gateway. Once the address is received your PC will have Internet access.
- 6 In the event your PC does not automatically request an IP address after completing the above steps, it is recommended that you select Windows **Start** button, then shutdown and restart Windows.
- 7 If you cannot access the Internet, go to *Having Difficulty?* (on page 34). If you still cannot access the Internet, contact your service provider for further assistance.

Configuring TCP/IP on Windows 2000 Systems

- 1 Click **Start**, select **Settings**, and choose **Network and Dial-up Connections**.
- 2 Double-click the **Local Area Connection** icon in the Network and Dial-up Connections window.
- 3 Click **Properties** in the Local Area Connection Status window.
- 4 Click **Internet Protocol (TCP/IP)** in the Local Area Connection Properties window, and then click **Properties**.
- 5 Select both **Obtain an IP address automatically** and **Obtain DNS server address automatically** in the Internet Protocol (TCP/IP) Properties window, and then click **OK**.

- 6 Click **Yes** to restart your computer when the Local Network window opens. The computer restarts. The TCP/IP protocol is now configured on your PC, and your Ethernet devices are ready for use.
- 7 Try to access the Internet. If you cannot access the Internet, go to *Having Difficulty?* (on page 34). If you still cannot access the Internet, contact your service provider for further assistance.

Configuring TCP/IP on Macintosh Systems

- 1 Click the **Apple** icon in the upper-left corner of the Finder. Scroll down to **Control Panels**, and then click **TCP/IP**.
- 2 Click **Edit** on the Finder at the top of the screen. Scroll down to the bottom of the menu, and then click **User Mode**.
- 3 Click **Advanced** in the User Mode window, and then click **OK**.
- 4 Click the Up/Down selector arrows located to the right of the Connect Via section of the TCP/IP window, and then click **Using DHCP Server**.
- 5 Click **Options** in the TCP/IP window, and then click **Active** in the TCP/IP Options window.
Note: Make sure that the **Load only when needed option** is *unchecked*.
- 6 Verify that the **Use 802.3** option located in the upper-right corner of the TCP/IP window is unchecked. If there is a check mark in the option, uncheck the option, and then click **Info** in the lower-left corner.
- 7 Is there a Hardware Address listed in this window?
 - If **yes**, click **OK**. To close the TCP/IP Control Panel window, click **File**, and then scroll down to click **Close**. You have completed this procedure.
 - If **no**, you must power off your Macintosh.
- 8 With the power off, simultaneously press and hold down the **Command (Apple)**, **Option, P**, and **R** keys on your keyboard. Keeping those keys pressed down, power on your Macintosh but do not release these keys until you hear the Apple chime at least three times, then release the keys and let the computer restart.
- 9 When your computer fully reboots, repeat steps 1 through 7 to verify that all TCP/IP settings are correct. If your computer still does not have a Hardware Address, contact your authorized Apple dealer or Apple technical support center for further assistance.

Having Difficulty?

Common Troubleshooting Issues

I don't understand the front panel status indicators

See *Front Panel LED Status Indicator Functions* (on page 36), for more detailed information on front panel LED status indicator operation and function.

The modem does not register an Ethernet connection

- Verify that your computer has an Ethernet card and that the Ethernet driver software is properly installed. If you purchase and install an Ethernet card, follow the installation instructions very carefully.
- Verify the status of the front panel LED status indicators.

The modem does not register an Ethernet connection after connecting to a hub

If you are connecting multiple PCs to the cable modem, you should first connect the modem to the uplink port of the hub. The **LINK** LED of the hub will illuminate continuously.

The modem does not register a cable connection

The modem works with a standard 75-ohm RF coaxial cable. If you are using a different cable, your cable modem will not function properly. Contact your service provider to determine whether you are using the correct cable.

There is no dial tone when I lift the telephone handset

- Your telephone wiring may be connected to the wrong RJ-11 port on the cable modem. The cable modem has two telephone ports. Verify that you are connected to the correct telephone port.
- There may be a problem with your telephone set. Use a different telephone set and listen to hear dial tone.
- There may be a problem with your home telephone wiring. Use a telephone and connect directly to the same RJ-11 port on the back of the unit. If the dial tone is working here but does not work at other locations in the home, a professional may need to diagnose and repair a problem with your telephone wiring.
- Verify that the phone company has removed the previous telephone service from your home telephone wiring.

Your telephone service may not be enabled from your cable telephony service provider. Contact your cable telephony service provider for more information.

Tips for Improved Performance

Check and Correct

If your cable modem does not perform as expected, the following tips may help. If you need further assistance, contact your service provider.

- Verify that the plug to your cable modem AC cord is properly inserted into an electrical outlet.
- Verify that your cable modem AC power cord is not plugged into an electrical outlet that is controlled by a wall switch. If a wall switch controls the electrical outlet, make sure the switch is in the **ON** position.
- Verify that the **POWER, DS, US** and **ONLINE** LED status indicators on the front panel of your cable modem are illuminated.
- Verify that your cable service is active and that it supports two-way service.
- Verify that all cables are properly connected, and that you are using the correct cables.
- Verify that your TCP/IP is properly installed and configured if you are using the Ethernet connection.
- Verify that you have followed the procedures in *Installing USB Drivers* (on page 27), if you are using the USB connection.
- Verify that you have called your service provider and given them the serial number and MAC address of your cable modem.
- If you are using a cable signal splitter so that you can connect the cable modem to other devices, remove the splitter and reconnect the cables so that the cable modem is connected directly to the cable input. If the cable modem now functions properly, the cable signal splitter may be defective and may need to be replaced.
- For best performance over an Ethernet connection, your PC should be equipped with a 10/100/1000BASE-T network interface card.

Front Panel LED Status Indicator Functions

Initial Power Up, Calibration, and Registration (AC Power applied)

The following chart illustrates the sequence of steps and the corresponding appearance of the cable modem front panel LED status indicators during power up, calibration, and registration on the network when AC power is applied to the cable modem. Use this chart to troubleshoot the power up, calibration, and registration process of your cable modem.

Note: After the cable modem completes Step 7 (Registration Completed), the modem proceeds immediately to Normal Operations. See *Normal Operations (AC Power Applied)* (on page 37).

Front Panel LED Status Indicators During Initial Power Up, Calibration, and Registration									
Step		1	2	3	4	5	6	7	8
Front Panel Indicator		Power Up	Self Test	Downstream Scan	Downstream Signal Lock	Ranging	Requesting IP Address	Registering	Registration Completed
1	POWER	On	On	On	On	On	On	On	On
2	DS	Blinking	On	Blinking	On	On	On	On	On
3	US	Blinking	On	Off	Off	Blinking	On	On	On
4	ONLINE	Blinking	On	Off	Off	Off	Off	Blinking	On
5	LINK	Off	On	On or Blinking	On or Blinking	On or Blinking	On or Blinking	On or Blinking	On or Blinking
6	TEL1	Off	On	Off	Off	Off	Off	Off	Off
	TEL2	Off	On	Off	Off	Off	Off	Off	Off
* The ONLINE LED illuminates continuously whenever a PC is connected to the modem, and it blinks to indicate that data is being transferred. If the modem is used to provide telephone service only and is not connected to a PC, the ONLINE LED is off.									

Normal Operations (AC Power Applied)

The following chart illustrates the appearance of the LED status indicators on the front panel of the cable modem during normal operations when AC power is applied to the modem.

Front Panel LED Status Indicators During Normal Operations		
Front Panel Indicator	Normal Operations	
1	POWER	On
2	DS	On
3	US	On
4	ONLINE	On
5	LINK*	<ul style="list-style-type: none"> ■ On - When a single device is connected to either the ETHERNET or USB port and no data is being sent to or from the modem ■ Blinks - When only one Ethernet or USB device is connected and data is being transferred between the consumer premise equipment (CPE) and the cable modem ■ Off - When no devices are connected to either the ETHERNET or USB ports
6	TEL1	<ul style="list-style-type: none"> ■ On - When VoIP service is enabled ■ Blinks - When Line 1 is in use
	TEL2	<ul style="list-style-type: none"> ■ On - When VoIP service is enabled ■ Blinks - When Line 2 is in use
<p>*With both Ethernet and USB devices connected to the modem at the same time, when data is being transferred through only one of the devices (Ethernet or USB), the indicator will illuminate continuously. Whenever data is being sent through both data ports (ETHERNET and USB) simultaneously, the indicator will blink as described.</p>		

Notices

Trademarks

Cisco, Cisco Systems, the Cisco logo, the Cisco Systems logo, and Scientific Atlanta are registered trademarks or trademarks of Cisco Systems, Inc. and/or its affiliates in the U.S. and certain other countries.

DOCSIS is a registered trademark of Cable Television Laboratories, Inc.

EuroDOCSIS, EuroPacketCable, and PacketCable are trademarks of Cable Television Laboratories, Inc.

All other trademarks mentioned in this document are the property of their respective owners.

Disclaimer

Cisco Systems, Inc. assumes no responsibility for errors or omissions that may appear in this guide. We reserve the right to change this guide at any time without notice.

Documentation Copyright Notice

Information in this document is subject to change without notice. No part of this document may be reproduced in any form without the express written permission of Cisco Systems, Inc.

Software and Firmware Use Notice

The software described in this document is protected by copyright law and furnished to you under a license agreement. You may only use or copy this software in accordance with the terms of your license agreement.

The firmware in this equipment is protected by copyright law. You may only use the firmware in the equipment in which it is provided. Any reproduction or distribution of this firmware, or any portion of it, without our express written consent is prohibited.



Service Provider Video Technology Group
5030 Sugarloaf Parkway, Box 465447
Lawrenceville, GA 30042

678.277.1000
www.scientificatlanta.com

This document includes various trademarks of Cisco Systems, Inc. Please see the Notices section of this document for a list of the Cisco Systems, Inc. trademarks used in this document.

Product and service availability are subject to change without notice.

© 2009 Cisco Systems, Inc. All rights reserved.

June 2009 Printed in United States of America

Part Number 4021203 Rev A